

Обработка профилей примыкания АУРС.F50.0740, АУРС.F50.0741, АУРС.F50.0742 при соединении стойки с ригелем под произвольным углом

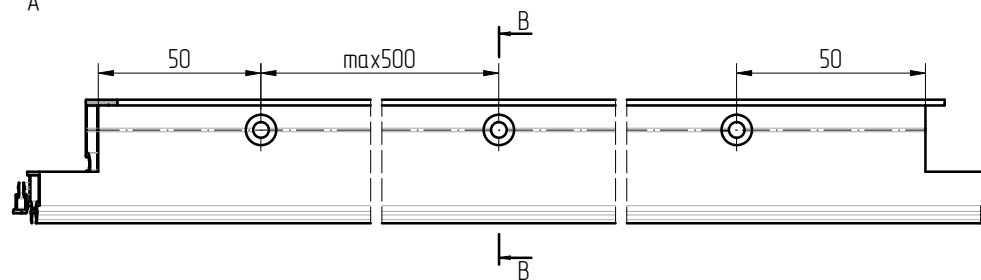

Для АУРС.F50.0740

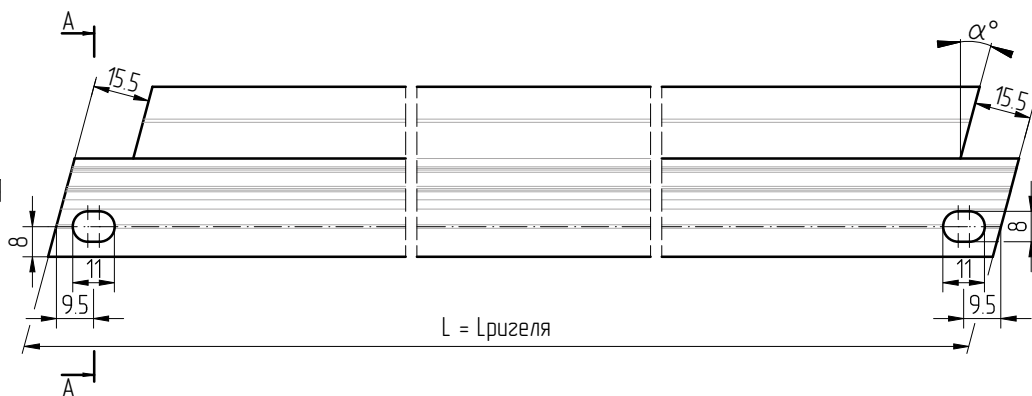
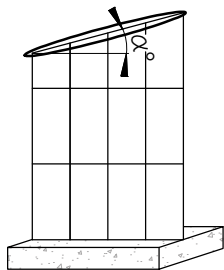
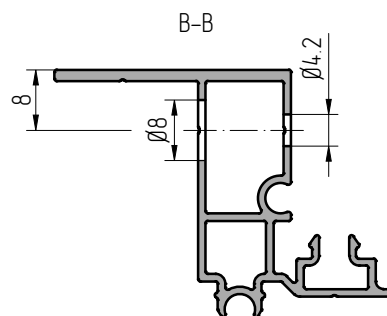
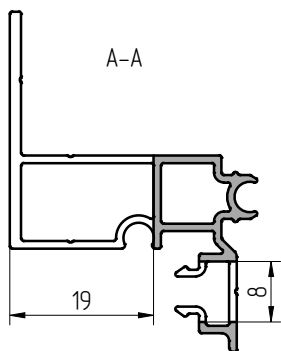

Для АУРС.F50.0741

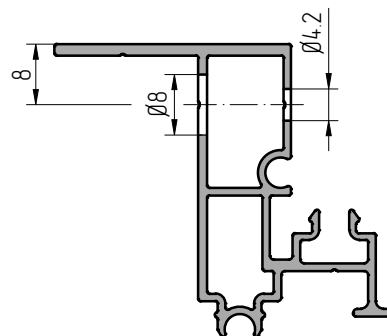
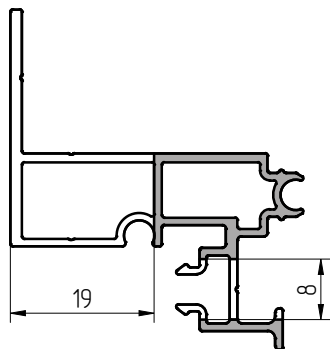

Для АУРС.F50.0742

